

Thin-Film Directional Couplers



CP0402 High Directivity LGA Termination

GENERAL DESCRIPTION

ITF (Integrated Thin-Film) TECHNOLOGY

The ITF High Directivity LGA Coupler is based on thin-film multilayer technology. The technology provides a miniature part with excellent high frequency performance and rugged construction for reliable automatic assembly.

The ITF Coupler is offered in a variety of frequency bands compatible with various types of high frequency wireless systems.

APPLICATIONS

- Mobile Communications
- Satellite TV Receivers
- GPS
- Vehicle Location Systems
- Wireless LAN's

FEATURES

- Inherent Low Profile
- Self Alignment during Reflow
- Excellent Solderability
- Low Parasitics
- Better Heat Dissipation
- Operating/Storage Temp -40°C to +85°C
- Power Rating 3W RF Cont

DIMENSIONS: (Bottom View)

millimeters (inches)

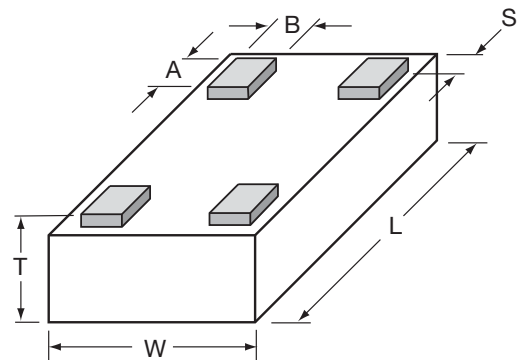

L	1.00±0.05 (0.040±0.002)
W	0.58±0.04 (0.023±0.002)
T	0.35±0.05 (0.014±0.002)

A	0.20±0.05 (0.008±0.002)
B	0.18±0.05 (0.007±0.002)
S	0.05±0.05 (0.002±0.002)

3

HOW TO ORDER

CP ┆ Style Directional Coupler	0402 ┆ Size 0402	X ┆ Type	**** ┆ Frequency (MHz)	X ┆ Sub Type	N ┆ LGA Termination L = LGA Sn90, Pb10 **N = LGA Sn100	TR ┆ Packaging Code TR = Tape and Reel
---	---	------------------------------	---	----------------------------------	--	---

**RoHS Compliant

QUALITY INSPECTION

Finished parts are 100% tested for electrical parameters and visual characteristics. Each production lot is evaluated on a sample basis for:

- Static Humidity: 85°C, 85% RH, 160 hours
- Endurance: 125°C, I_R, 4 hours

TERMINATION

Sn90Pb10 or Lead-Free Sn100 Nickel/Solder coating compatible with automatic soldering technologies: reflow, wave soldering, vapor phase and manual.

TERMINALS (Top View)

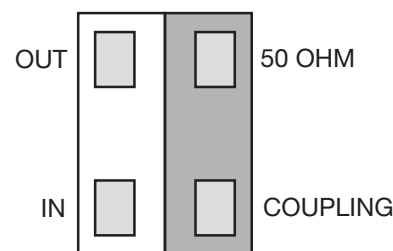

ORIENTATION IN TAPE

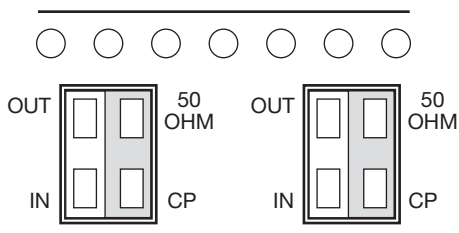

Recommended Pad Layout Dimensions

mm (inches)

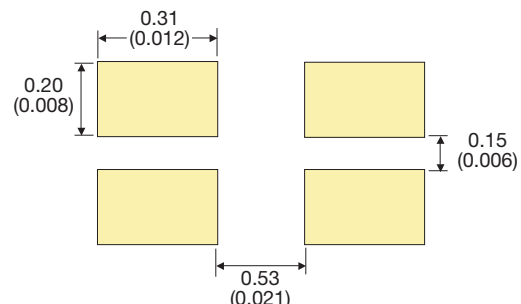

*The recommended distance to the PCB Ground Plane is 0.254mm (0.010")

Thin-Film Directional Couplers



CP0402 High Directivity LGA Termination

COUPLER TYPE SELECTION GRAPH

Coupling vs. Frequency

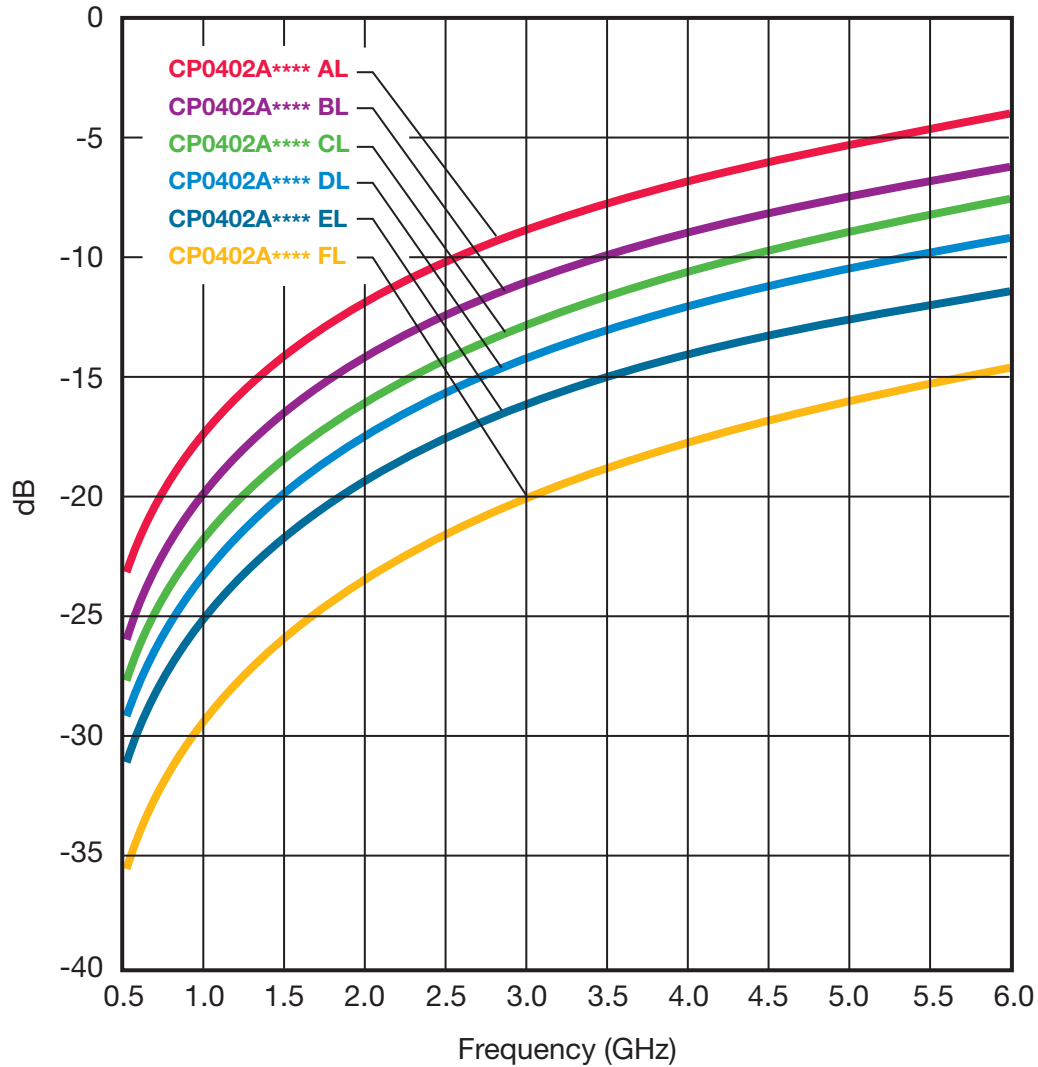

3

Intermediate coupling factors are readily available.
Please contact factory.

Thin-Film Directional Couplers



CP0402 High Directivity LGA Termination

Coupler P/N CP0402AxxxxAL

Application	P/N Examples	Frequency Band [MHz]	Coupling [dB]	I. Loss max. [dB]	Return Loss [dB]	Directivity [dB]
AMPS	CP0402A0836AL	824 - 849	19.10	0.25	32	21
	CP0402A0881AL	869 - 894	18.60			
GSM	CP0402A0902AL	890 - 915	18.50	0.25	31	
	CP0402A0947AL	935 - 960	18.00			
E-GSM	CP0402A0897AL	880 - 915	18.50	0.25	31	
	CP0402A0942AL	925 - 960	18.00			
PDC	CP0402A1441AL	1429 - 1453	14.50	0.40	28	
PCN	CP0402A1747AL	1710 - 1785	13.00	0.50	26	
	CP0402A1842AL	1805 - 1880	12.50			
PCS	CP0402A1880AL	1850 - 1910	12.30	0.50	25	
	CP0402A1960AL	1930 - 1990	12.00			
PHP	CP0402A1907AL	1895 - 1920	12.30	0.70	23	
DECT	CP0402A1890AL	1880 - 1900	12.30	0.70	23	
Wireless LAN	CP0402A2442AL	2400 - 2484	10.30	0.70	23	

CP0402AxxxxALTR

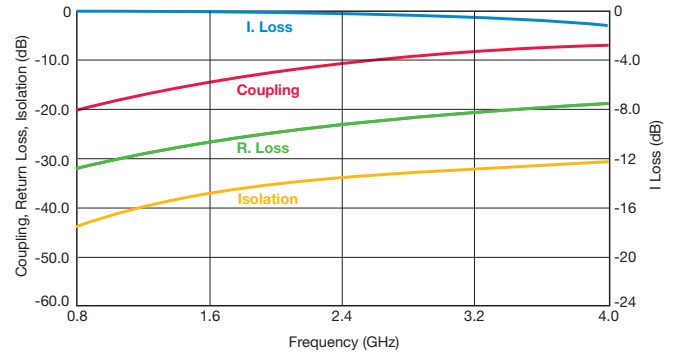

Coupler P/N CP0402AxxxxBL

Application	P/N Examples	Frequency Band [MHz]	Coupling [dB]	I. Loss max. [dB]	Return Loss [dB]	Directivity [dB]
AMPS	CP0402A0836BL	824 - 849	22.00	0.20	28	27
	CP0402A0881BL	869 - 894	21.70			
GSM	CP0402A0902BL	890 - 915	21.50	0.25	27	
	CP0402A0947BL	935 - 960	21.00			
E-GSM	CP0402A0897BL	880 - 915	21.50	0.20	28	
	CP0402A0942BL	925 - 960	21.00			
PDC	CP0402A1441BL	1429 - 1453	17.50	0.25	24	
PCN	CP0402A1747BL	1710 - 1785	16.00	0.30	23	
	CP0402A1842BL	1805 - 1880	15.50			
PCS	CP0402A1880BL	1850 - 1910	15.00	0.35	22	
	CP0402A1960BL	1930 - 1990	15.00			
PHP	CP0402A1907BL	1895 - 1920	15.50	0.40	21	
DECT	CP0402A1890BL	1880 - 1900	15.50	0.40	21	
Wireless LAN	CP0402A2442BL	2400 - 2484	13.30	0.40	21	

CP0402AxxxxBLTR

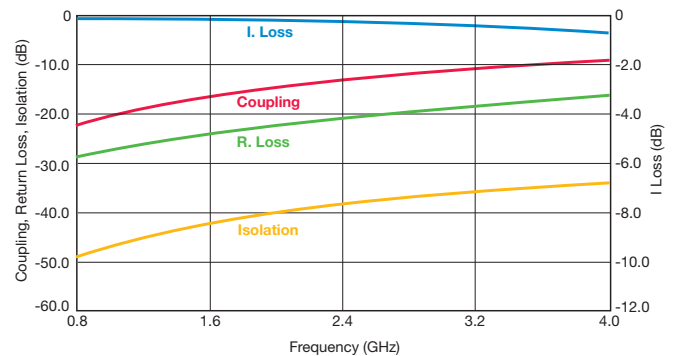

Coupler P/N CP0402AxxxxCL

Application	P/N Examples	Frequency Band [MHz]	Coupling [dB]	I. Loss max. [dB]	Return Loss [dB]	Directivity [dB]
AMPS	CP0402A0836CL	824 - 849	23.60	0.20	33	22
	CP0402A0881CL	869 - 894	23.00			
GSM	CP0402A0902CL	890 - 915	22.50	0.25	33	
	CP0402A0947CL	935 - 960	22.50			
E-GSM	CP0402A0897CL	880 - 915	23.00	0.25	32	
	CP0402A0942CL	925 - 960	22.50			
PDC	CP0402A1441CL	1429 - 1453	19.00	0.25	31	
PCN	CP0402A1747CL	1710 - 1785	17.20	0.25	30	
	CP0402A1842CL	1805 - 1880	17.00			
PCS	CP0402A1880CL	1850 - 1910	16.80	0.25	29	
	CP0402A1960CL	1930 - 1990	16.50			
PHP	CP0402A1907CL	1895 - 1920	16.80	0.45	28	
DECT	CP0402A1890CL	1880 - 1900	16.80	0.45	28	
Wireless LAN	CP0402A2442CL	2400 - 2484	14.70	0.45	28	

CP0402AxxxxCLTR

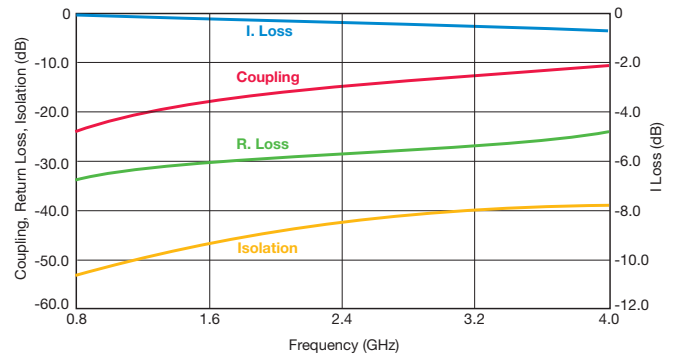

Important: Couplers can be used at any frequency within the indicated range.

Thin-Film Directional Couplers



CP0402 High Directivity LGA Termination

Coupler P/N CP0402AxxxxDL

Application	P/N Examples	Frequency Band [MHz]	Coupling [dB]	I. Loss max. [dB]	Return Loss [dB]	Directivity [dB]	
AMPS	CP0402A0836DL	824 - 849	25.20	0.20	29	20	
	CP0402A0881DL	869 - 894	24.80				
GSM	CP0402A0902DL	890 - 915	24.70				
	CP0402A0947DL	935 - 960	24.10				
E-GSM	CP0402A0897DL	880 - 915	24.70				
	CP0402A0942DL	925 - 960	24.10				
PDC	CP0402A1441DL	1429 - 1453	20.50		25		
PCN	CP0402A1747DL	1710 - 1785	19.00		24		
	CP0402A1842DL	1805 - 1880	18.50				
PCS	CP0402A1880DL	1850 - 1910	18.20		0.25		23
	CP0402A1960DL	1930 - 1990	18.00				
PHP	CP0402A1907DL	1895 - 1920	18.10				
DECT	CP0402A1890DL	1880 - 1900	18.20				
Wireless LAN	CP0402A2442DL	2400 - 2484	16.00	0.35		22	

CP0402AxxxxDLTR

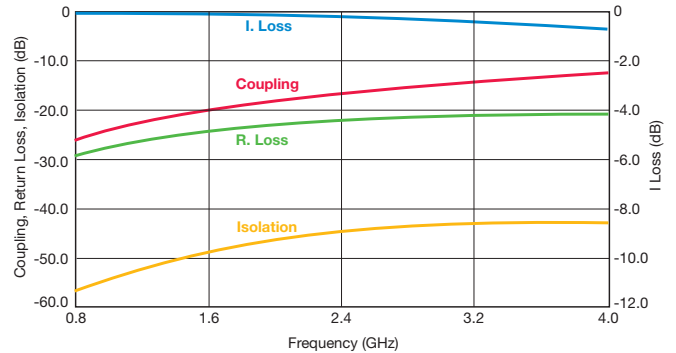

Coupler P/N CP0402AxxxxEL

Application	P/N Examples	Frequency Band [MHz]	Coupling [dB]	I. Loss max. [dB]	Return Loss [dB]	Directivity [dB]		
AMPS	CP0402A0836EL	824 - 849	27.20	0.20	35	25		
	CP0402A0881EL	869 - 894	26.80					
GSM	CP0402A0902EL	890 - 915	26.50					
	CP0402A0947EL	935 - 960	26.00					
E-GSM	CP0402A0897EL	880 - 915	26.50					
	CP0402A0942EL	925 - 960	26.00					
PDC	CP0402A1441EL	1429 - 1453	22.30		29			
PCN	CP0402A1747EL	1710 - 1785	20.50		27			
	CP0402A1842EL	1805 - 1880	20.30					
PCS	CP0402A1880EL	1850 - 1910	20.00		26		23	
	CP0402A1960EL	1930 - 1990						
PHP	CP0402A1907EL	1895 - 1920						
DECT	CP0402A1890EL	1880 - 1900						
Wireless LAN	CP0402A2442EL	2400 - 2484		18.00		0.35		23

CP0402AxxxxELTR

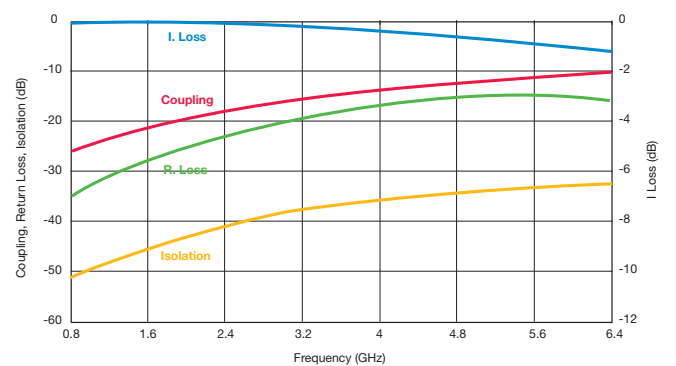

Coupler P/N CP0402AxxxxFL

Application	P/N Examples	Frequency Band [MHz]	Coupling [dB]	I. Loss max. [dB]	Return Loss [dB]	Directivity [dB]
AMPS	CP0402A0836FL	824 - 849	31.00	0.20	29.10	11
	CP0402A0881FL	869 - 894	30.70		28.60	
GSM	CP0402A0902FL	890 - 915	30.60		28.50	
	CP0402A0947FL	935 - 960	30.00		28.10	
E-GSM	CP0402A0897FL	880 - 915	30.60		28.50	
	CP0402A0942FL	925 - 960	30.00		28.10	
PDC	CP0402A1441FL	1429 - 1453	26.50		25.00	
PCN	CP0402A1747FL	1710 - 1785	25.00		23.80	
	CP0402A1842FL	1805 - 1880	24.50		23.60	
PCS	CP0402A1880FL	1850 - 1910	24.20		23.50	
	CP0402A1960FL	1930 - 1990	24.00	23.30		
PHP	CP0402A1907FL	1895 - 1920	24.20	23.40		
DECT	CP0402A1890FL	1880 - 1900		23.50		
Wireless LAN	CP0402A2442FL	2400 - 2484		22.00	0.25	22.60

CP0402AxxxxFLTR

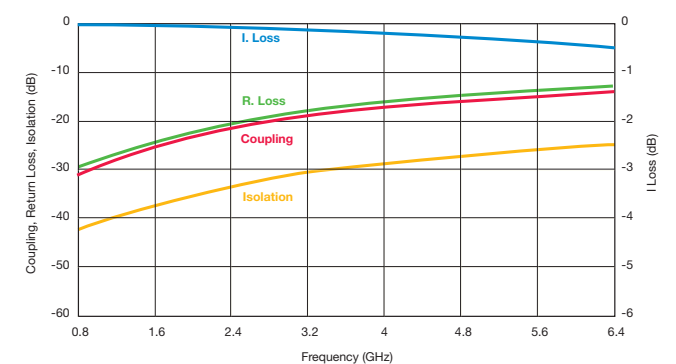

Important: Couplers can be used at any frequency within the indicated range.



Thin-Film Directional Couplers



CP0402 / CP0603 High Directivity Couplers Test Jigs

GENERAL DESCRIPTION

These jigs are designed for testing the CP0402 and CP0603 High Directivity Couplers using a Vector Network Analyzer.

They consist of a dielectric substrate, having 50Ω microstrips as conducting lines and a bottom ground plane located at a distance of 0.254mm (0.010") from the microstrips.

The substrate used is Neltec's NH9338ST0254C1BC.

The connectors are SMA type (female), 'Johnson Components Inc.' Product P/N: 142-0701-841.

Both a measurement jig and a calibration jig are provided.

The calibration jig is designed for a full 2-port calibration, and consists of an open line, short line and through line. LOAD calibration can be done by a 50Ω SMA termination.

MEASUREMENT PROCEDURE

When measuring a component, it can be either soldered or pressed using a non-metallic stick until all four ports touch the appropriate pads. Set the VNA to the relevant frequency band. Connect the VNA using a 10dB attenuator on the jig

terminal connected to port 2. Follow the VNA's instruction manual and use the [calibration jig](#) to perform a full 2-Port calibration in the required bandwidths.

3

Place the coupler on the [measurement jig](#) as follows:

Input (Coupler) → Connector 1 (Jig) Termination (Coupler) → Connector 3 (Jig)
Output (Coupler) → Connector 2 (Jig) Coupling (Coupler) → Connector 4 (Jig)

To measure I. Loss connect:

Connector 1 (Jig) → Port 1 (VNA) Connector 3 (Jig) → 50Ω
Connector 2 (Jig) → Port 2 (VNA) Connector 4 (Jig) → 50Ω

To measure R. Loss and Coupling connect:

Connector 1 (Jig) → Port 1 (VNA) Connector 3 (Jig) → 50Ω
Connector 2 (Jig) → 50Ω Connector 4 (Jig) → Port 2 (VNA)

To measure Isolation connect:

Connector 1 (Jig) → 50Ω Connector 3 (Jig) → 50Ω
Connector 2 (Jig) → Port 1 (VNA) Connector 4 (Jig) → Port 2 (VNA)

